

## Features

- Bask® heated surface creates spa-like relaxation with soothing warmth on your back, shoulders, and neck.
- Three heat settings allow you to customize the surface temperature.
- Single-speed whirlpool offers performance and value with 8 fully adjustable jets.
- Hydromassage flow and direction can be controlled at each jet.
- Comfort Depth® design offers a convenient 19" step-over height while retaining the same depth as a standard 21" bath.
- Integral lumbar support and armrests offer extra comfort while bathing.
- Slotted overflow allows for deep soaking.
- Textured bottom surface.
- Integral apron.
- Integral flange helps prevent water from seeping behind wall and simplifies alcove installation.
- Coordinates with other products in the Archer collection.

## Material

- Acrylic.

## Hydrotherapy

- Whirlpool.

## Installation

- Left drain.
- Alcove.

## Required Products/Accessories

K-7271 Brass Slotted Overflow Bath Drain

or

K-7272 PVC Slotted Overflow Bath Drain

## Recommended Products/Accessories

K-24916 Wireless Music Kit

K-23726 Drain treatment

K-23732 Tub & shower cleaner



**ADA**

## Codes/Standards

ASME A112.19.7/CSA B45.10

CSA B45.5/IAPMO Z124

UL 1795

CSA C22.2 No. 218.2

ADA









ICC/ANSI A117.1

## KOHLER® Plastic Baths and Receptors Lifetime Limited Warranty KOHLER® Hydrotherapy Components Five-Year Limited Warranty

See website for detailed warranty information.

## Available Colors/Finishes

*Color tiles intended for reference only.*

Color	Code	Description
	0	White
	96	Biscuit
	NY	Dune
	95	Ice™ Grey
	G9	Sandbar
	33	Mexican Sand™
	K4	Cashmere
	58	Thunder™ Grey
	7	Black Black™

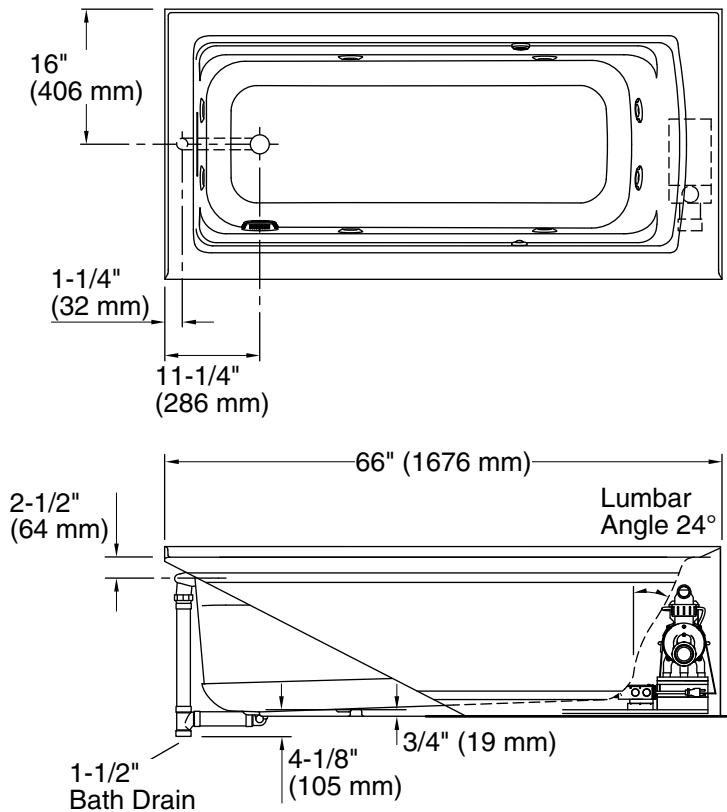

No change in measurements if connected with drain illustrated. (K-7272)

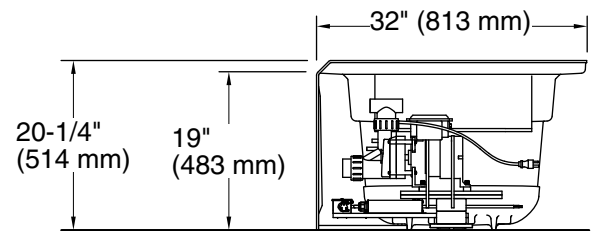
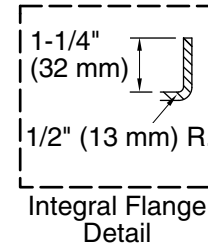

### Required Electrical Service

One dedicated circuit required, protected with Class A Ground-Fault Circuit-Interrupter (GFCI). Outside North America, this device may be known as a Residual Current Device (RCD).

Pump, Heated Surface: 120 V, 15 A, 60 Hz

### Technical Information

All product dimensions are nominal.

Installation: Three-wall alcove  
 Drain location: Left  
 Basin area, bottom: 50-3/8" x 19-5/8" (1280 mm x 498 mm)  
 Basin area, top: 57-5/16" x 24-1/16" (1456 mm x 611 mm)  
 Weight: 130 lbs (59 kg)  
 Minimum floor load: 48.1 lbs/ft<sup>2</sup> (234.8 kg/m<sup>2</sup>)  
 Water depth: 15-5/16" (389 mm)  
 Water capacity: 66 gal (249.8 L)  
 Electrical component rating: Pump: 120 V, 7 A, 60 Hz  
 Heated Surface: 120 V, 0.5 A, 60 Hz, 65 W  
 Pump speed: Single

### Notes

Measure your actual product for rough-in details.

Install this product according to the installation instructions.

The hot water supply should be 70% of the capacity of the bath or greater. Installations will vary.

ADA compliant when installed to the specific requirements of these regulations.